

PENSTOCKS

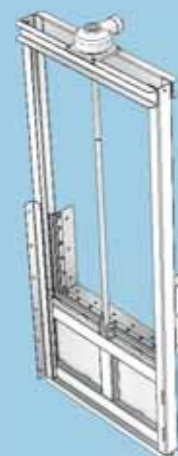

05-010-4L
4 sides sealed penstock

05-010-3L
3 sides sealed penstock



05-502
Adjustable weir

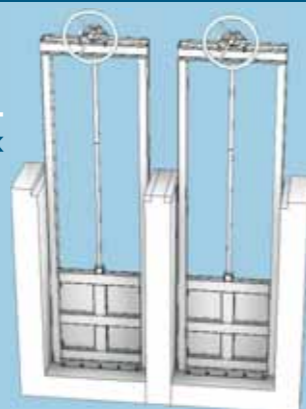

05-010-2B
3 sides sealed penstock
double shutter



05-010-P
Stop logs

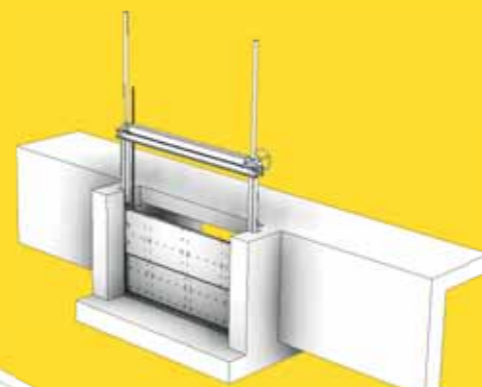

05-0343
Hydraulic screen for
irrigation plants

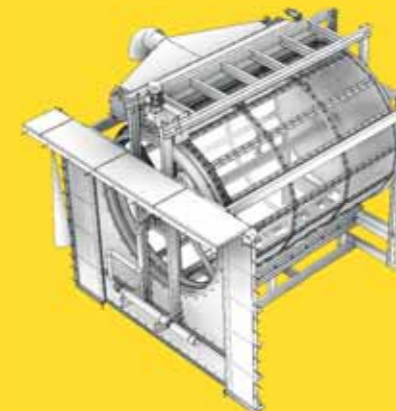

05-0380
Rotary drum screen for
irrigation plants



05-540B
Metallic mesh conveyor belt



We follow your projects from **DESIGN TO START-UP**



We focus on **QUALITY, PERFORMANCES, DURABILITY and SAFETY**



We **CUSTOMIZE** our machines to your needs



The best **KNOW-HOW** for machines and equipment



SIDERurgica del POlesine s.r.l.
Viale delle Industrie, 9 - 45100 Rovigo - ITALY
Tel +39 0425 475922 - info@siderpol.it
www.siderpol.it



SIDERURGICA DEL POLESINE IS AN ITALIAN LEADER IN THE WATER TREATMENT EQUIPMENT MANUFACTURING.

The modern structure of our organization allows a dynamic management of our operations. The company has a highly structured production site, an outstanding technological level and a dynamic staff. It is equipped with the most advanced tools to process complex orders. We control all the order phases internally: from the initial consulting phase with the customer, to finalize the best solution for his needs, through designing, manufacturing, internal quality checks, to installation at the customer's site, training of his staff and after sales services such as maintenance and assistance.

SCREENS



05-024
Screw storm screen



05-0310
Mechanical curved screen



05-0333
Chain screen heavy duty

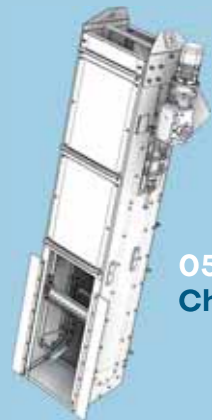

05-0334
Chain screen



05-0344
Hydraulic screen

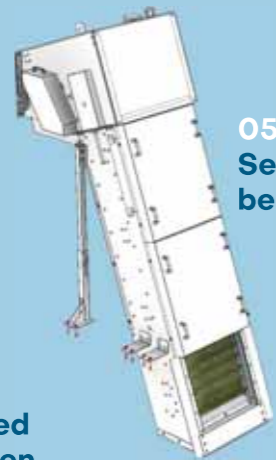

05-0350
Self cleaning belt screen

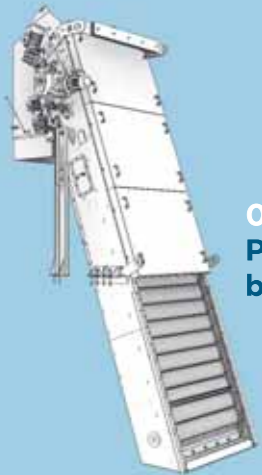

05-0351
Perforated belt screen



05-0352
Rotary drum strainer



05-0360 MINI
Mini screw screen



05-0367
Rotary drum screen

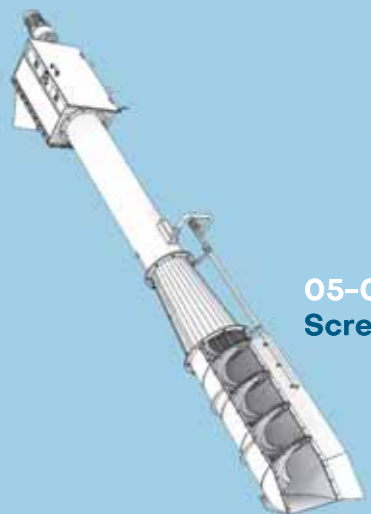

05-0362
Screw screen

COMPACT SYSTEMS



05-056
Sand separator



05-056W
Washer sand separator



05-054
Vortex sand separator



05-151
Mixer



05-152
Vertical reactor



05-0363
Screw screen in tank

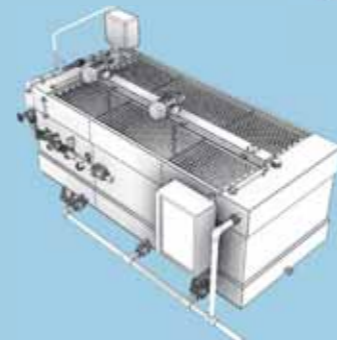

05-560
Polymer preparation unit

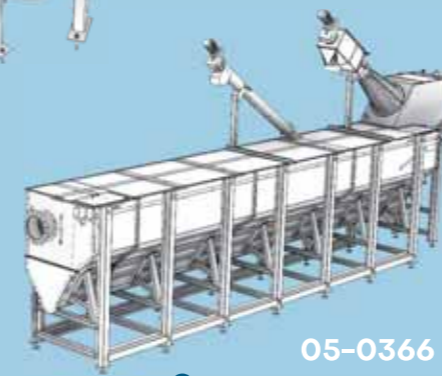

05-0366
Compact sewage pre-treatment station

SCRAPERS



05-057
To & fro desanding suction bridge



05-053
To & fro desanding scraper bridge



05-071
Peripheral drive scraper bridge



05-073
Central drive scraper bridge



05-074
Chain scraper



05-076
To & fro sludge scraper bridge

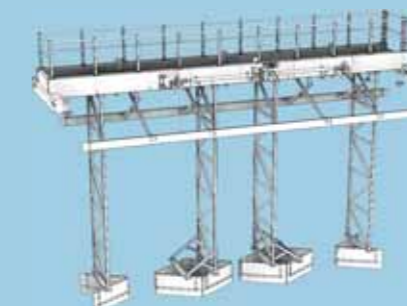

05-078
To & fro sludge suction bridge

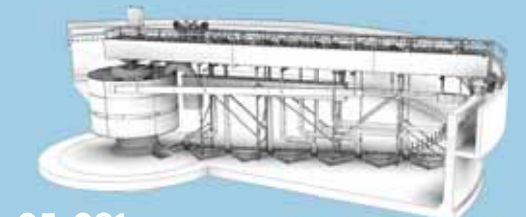

05-091
Peripheral drive sludge suction bridge

CONVEYORS



05-540
Conveyor belt



05-022
Screw conveyor



05-544W
Screw compactor with washing

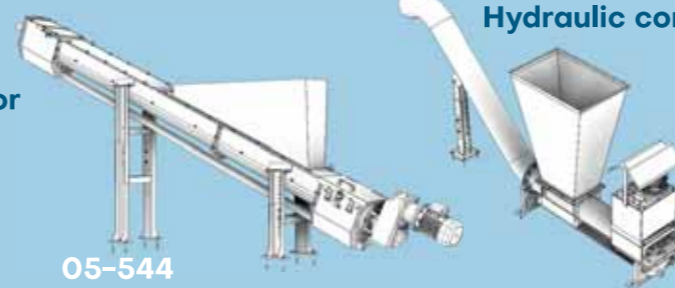

05-544
Screw compactor



05-542
Hydraulic compactor



05-093
Clariflocculator

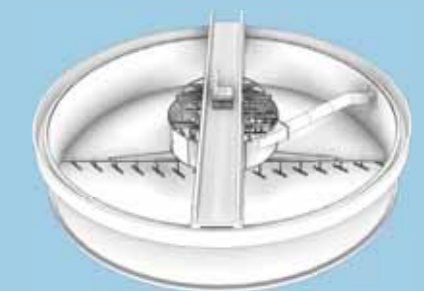

05-096
Turbocoagulator

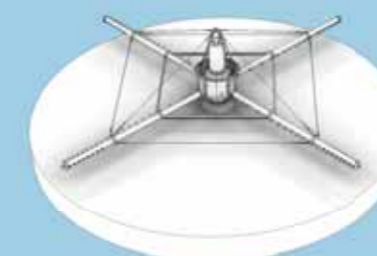

05-101
Rotary distributor for trickling filters



05-111
Sludge thickener